

Homsher Homes - Woodside Bungalow  
Kim or Dave Homsher  
5166 Campbellsport Rd.  
Ravenna OH 44266  
(330) 296-7757

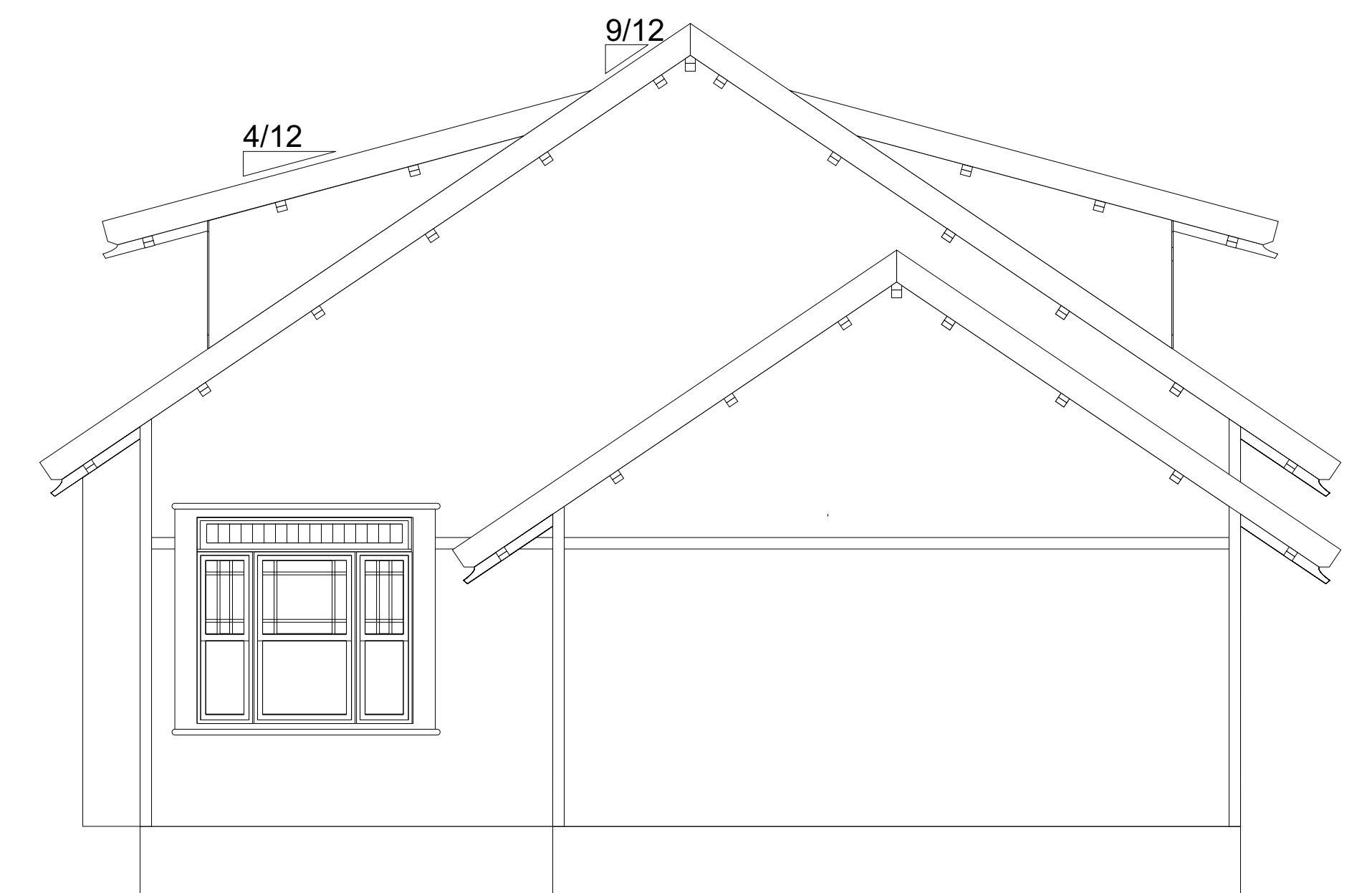

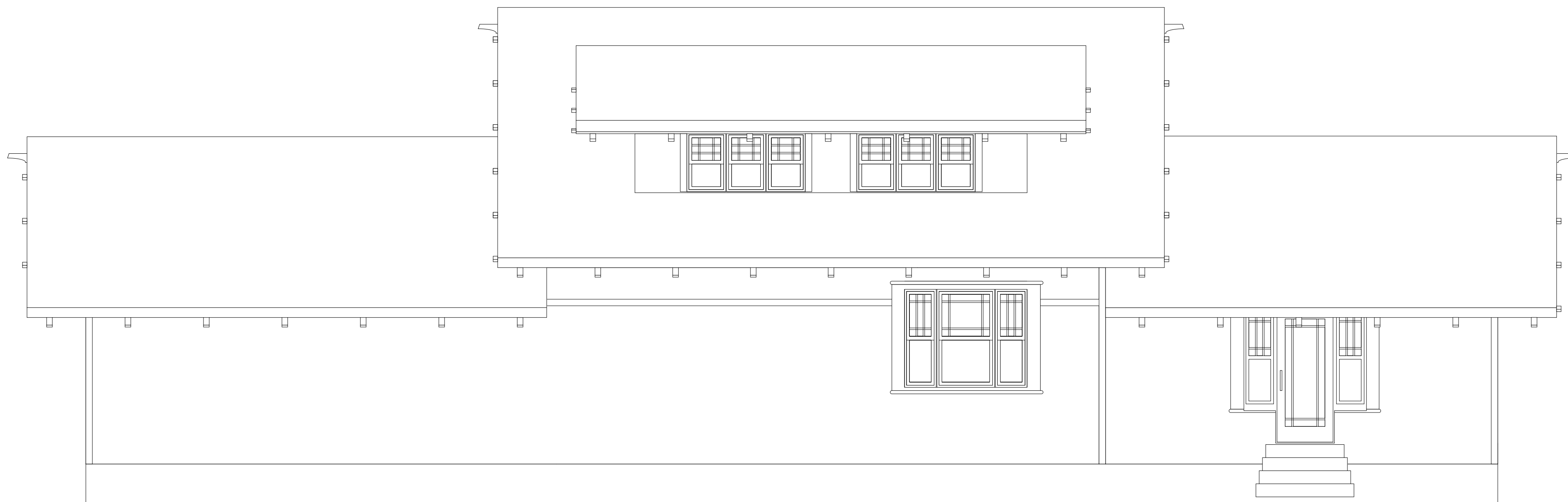

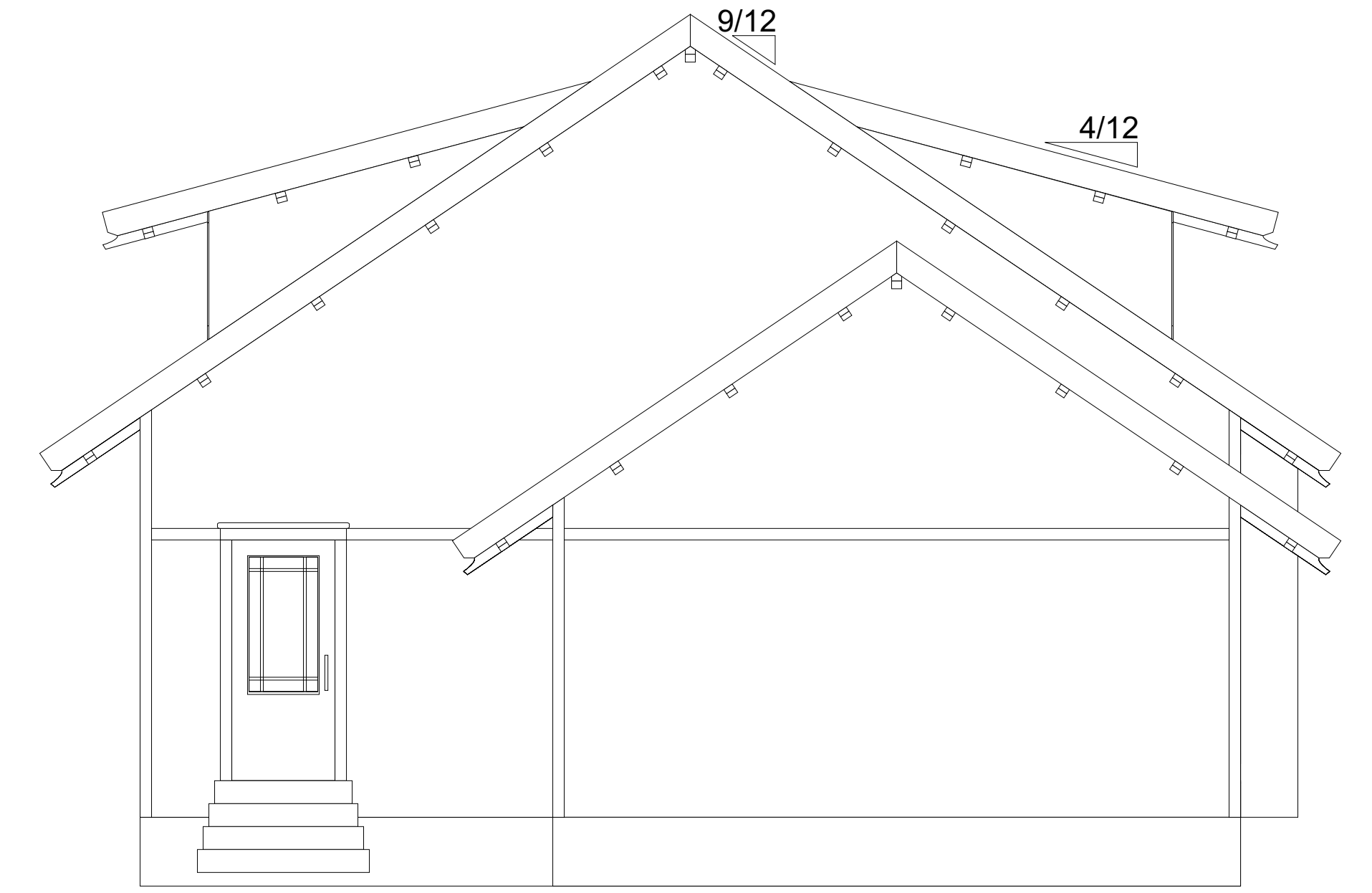
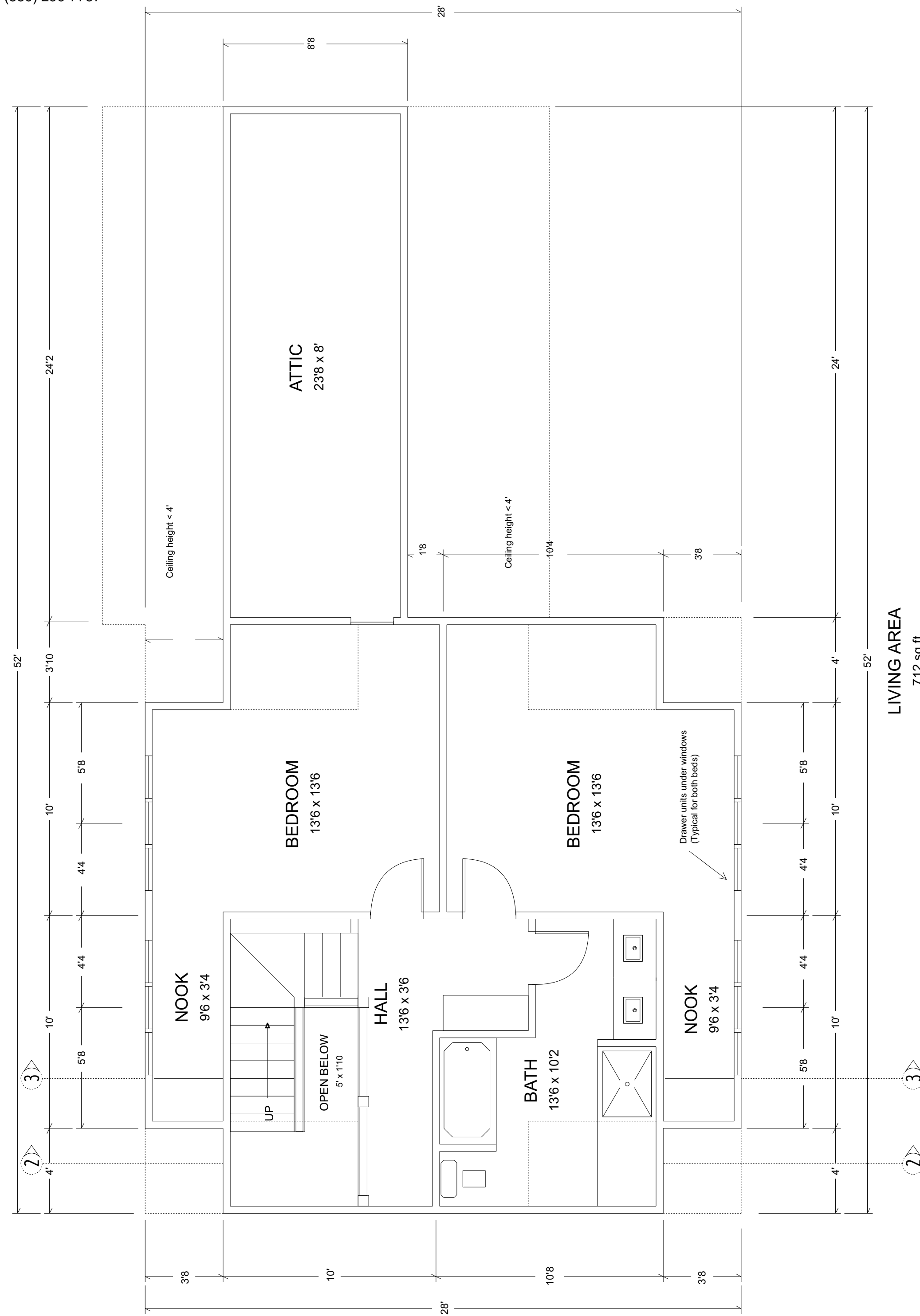

LIVING AREA  
712 sq ft

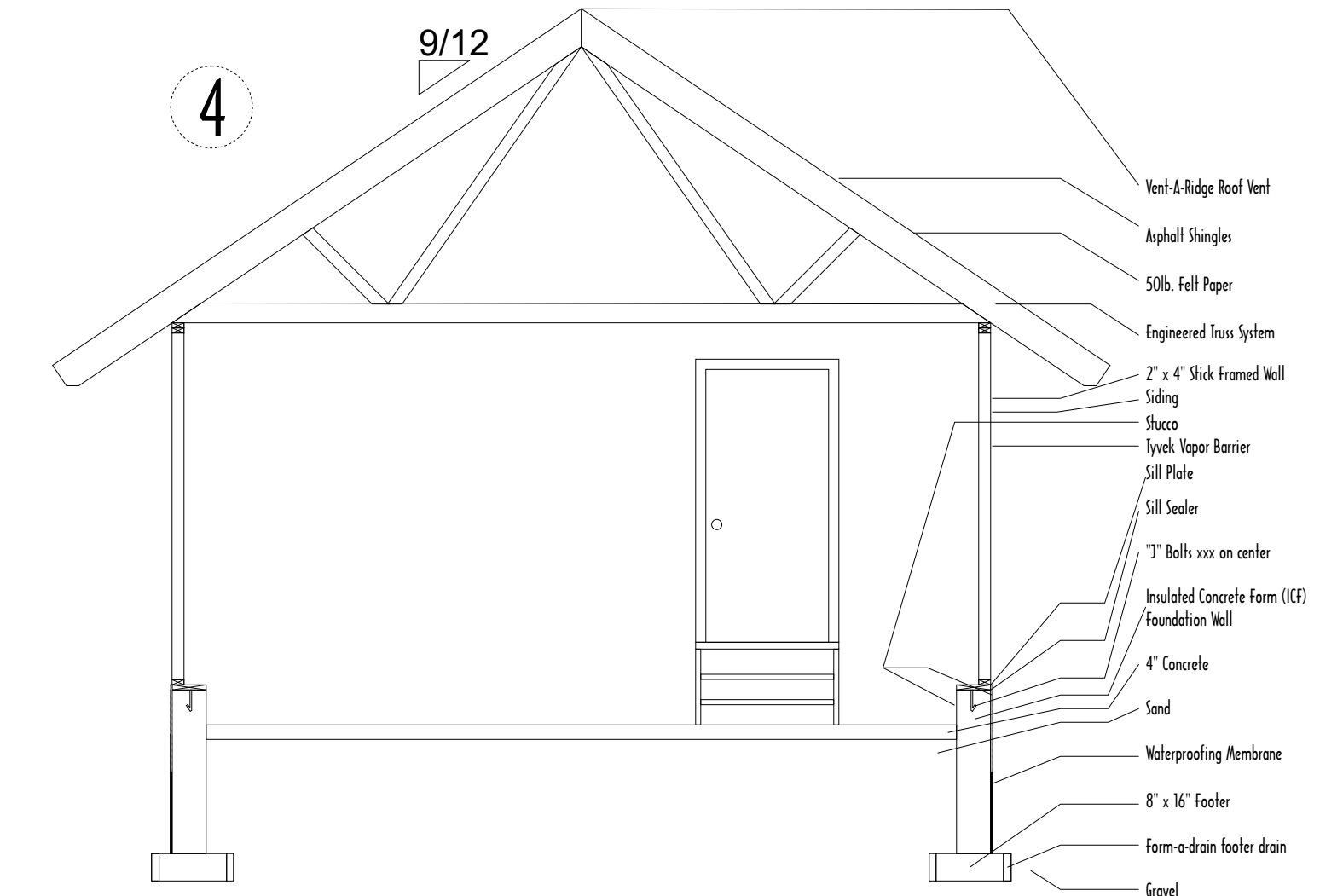
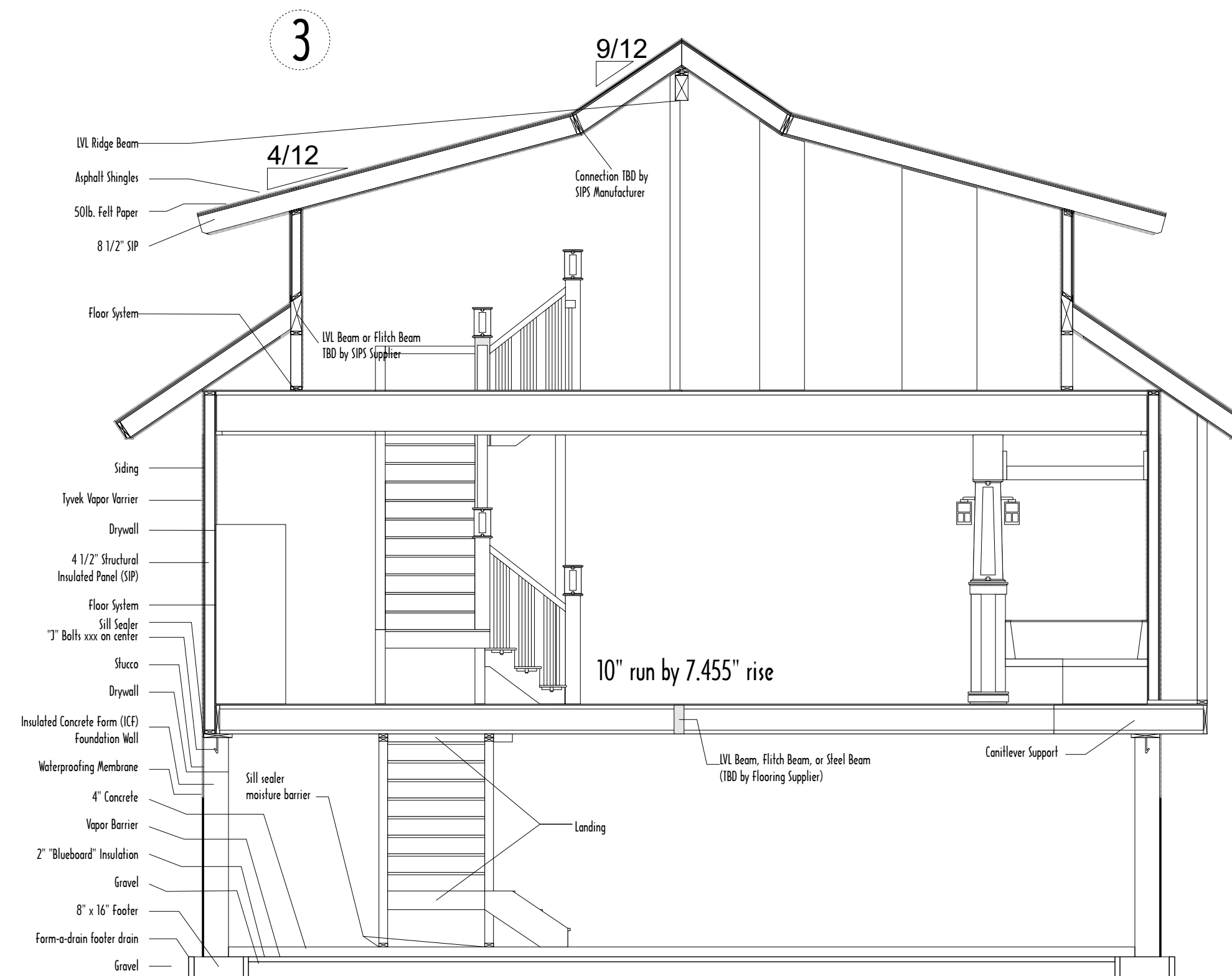
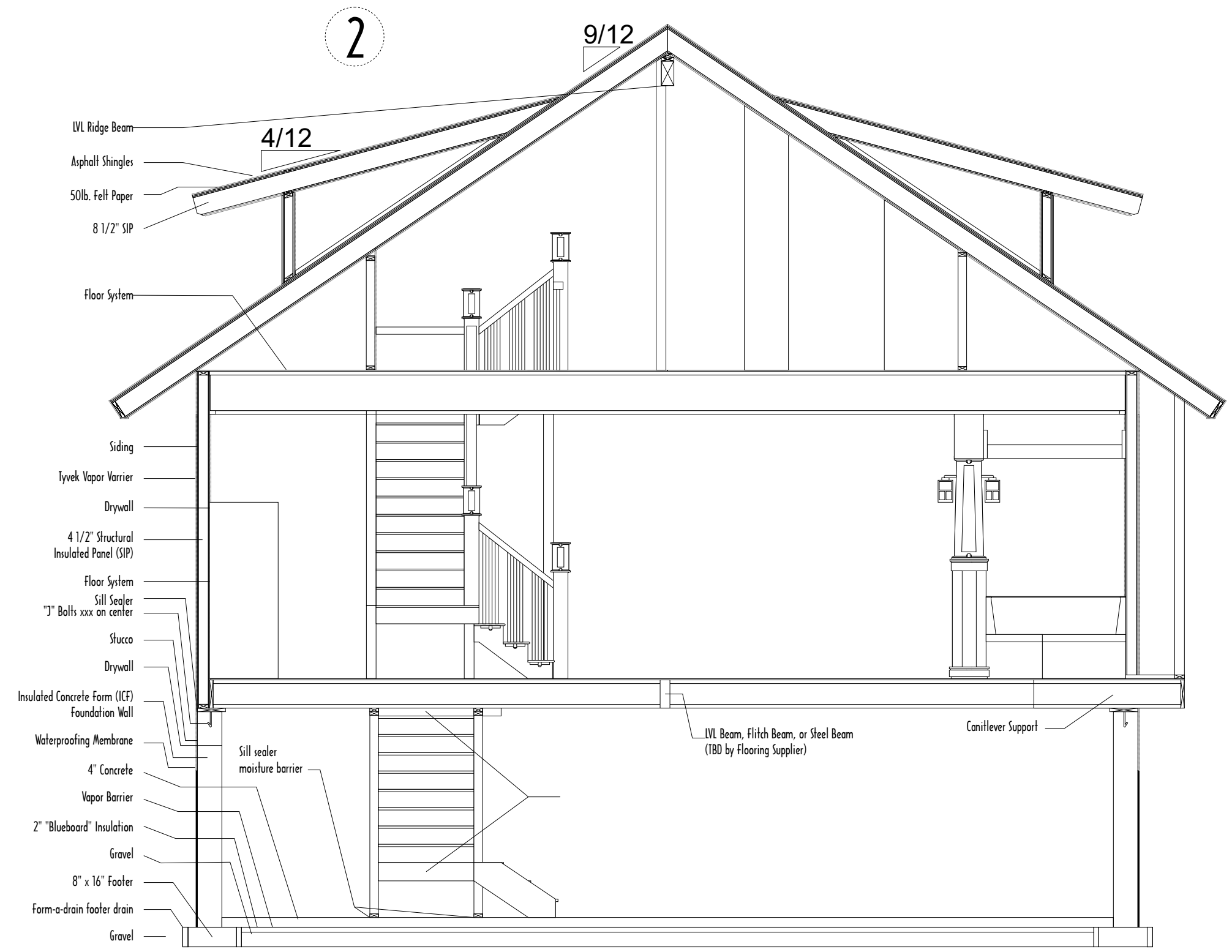
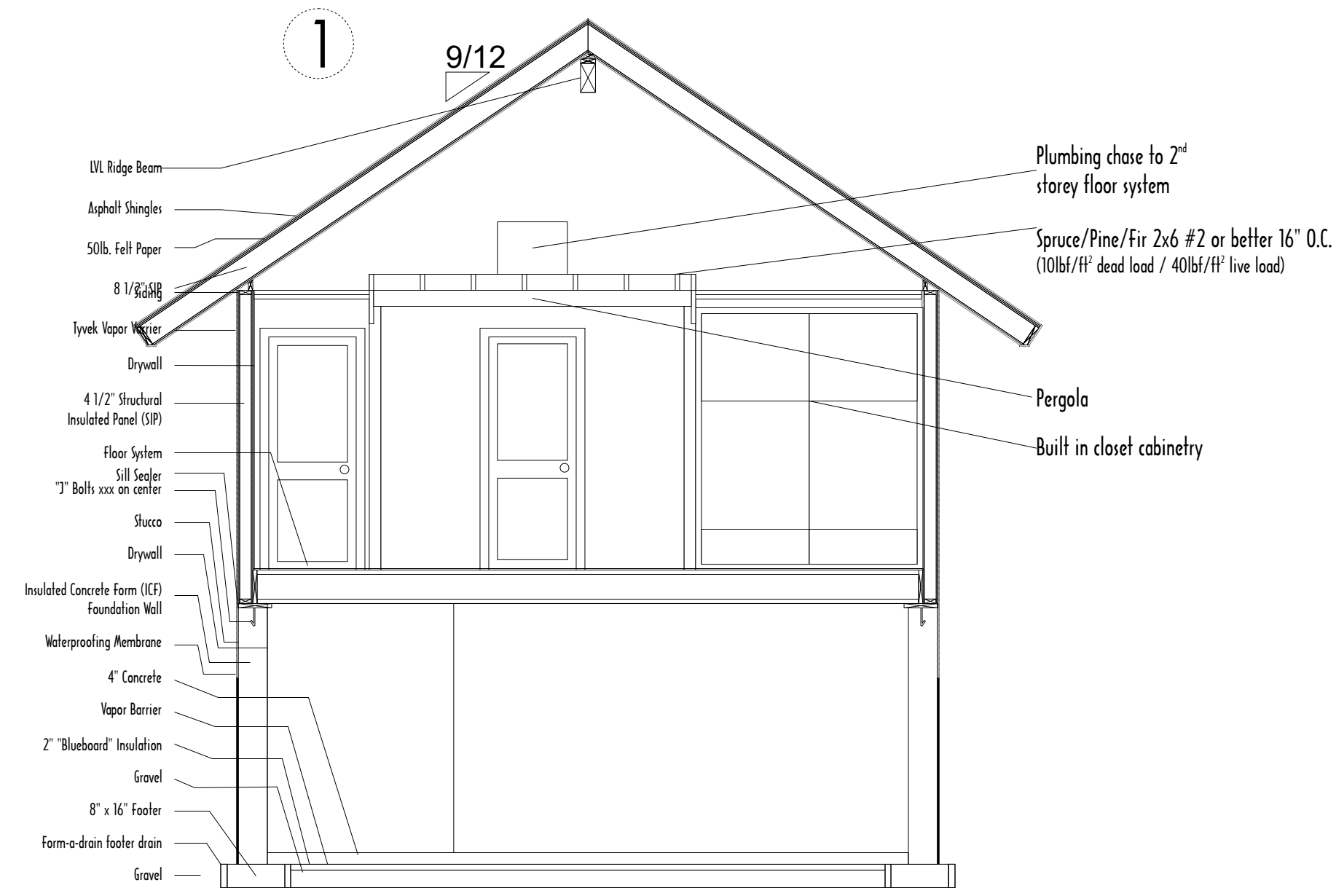

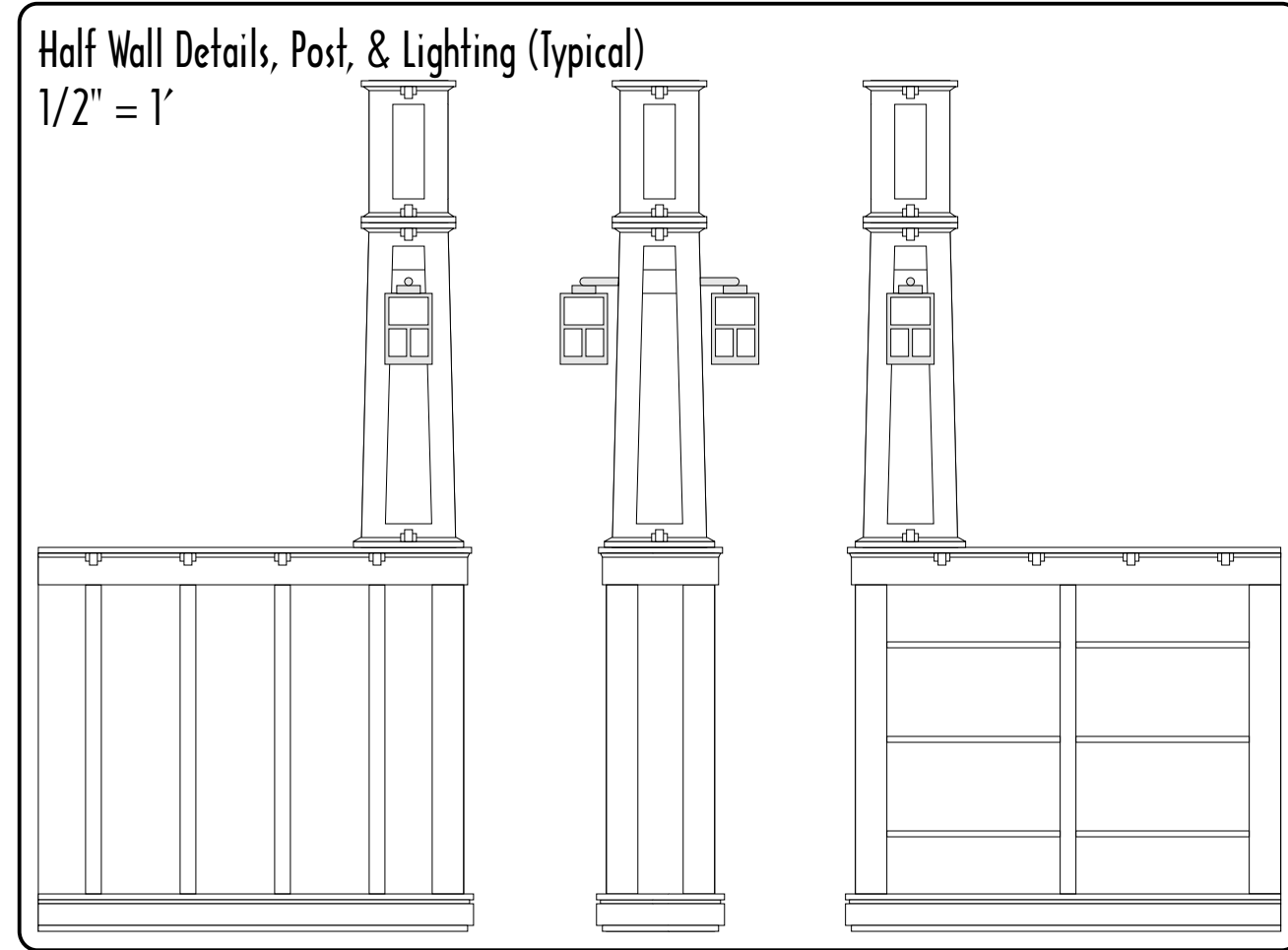

Window and Patio Door Schedule  
 Woodside Bungalow

Ref	Description	Qty	Unit Dimensions.....		Rough Opening Dimensions....	
			Width	Height	Width	Height
<b>1st Floor Short Triple</b>						
200	244DH1850	2	6'-3 1/2"	4'-11 1/2"	6'-4"	5'-0"
200	244DH3050	1	1'-7 1/2"	4'-11 1/2"		
			2'-11 1/2"	4'-11 1/2"		
<b>1st Floor Front Door+Windows</b>						
200	244DH1850	2	6'-3 5/16"	7'-10 5/16"	6'-3 7/8"	7'-10 3/4"
400	DHT6210	1	1'-7 1/2"	4'-11 1/2"		
400	FWO31611	1	6'-3 5/16"	1'-0"		
		-0-	3'-0 1/8"	6'-10 5/16"		
<b>1st Floor Back Door+Windows</b>						
200	244DH1850	1	6'-3 5/16"	6'-10 5/16"	6'-3 7/8"	6'-10 3/4"
200	244DH1850	2	1'-7 1/2"	4'-11 1/2"		
400	FWO31611	-0-	3'-0 1/8"	6'-10 5/16"		
<b>Typical 1st Floor Triple</b>						
200	244DH1850	2	6'-3 1/2"	5'-11 1/2"	6'-4"	6'-0"
200	244DH3050	2	1'-7 1/2"	4'-11 1/2"		
200	244DH3050	1	2'-11 1/2"	4'-11 1/2"		
400	DHT6210	1	6'-3 5/16"	1'-0"		
<b>Typical 2nd Floor Triple</b>						
200	244DH2030	4	5'-11 1/2"	2'-11 1/2"	6'-0"	3'-0"
200	244DH2030	3	1'-11 1/2"	2'-11 1/2"		

